



ENAPART



93 S Railroad Avenue Unit C
Bergenfield NJ 07621 USA
www.enapart.com
sales@enapart.com



Via del Canneto 35,
Borgosatollo, Brescia - Italia
www.enapart.it
vendite@enapart.it



Barbaros Mah. Ihlamur Bul. Aĝaoĝlu
My Newwork No:3/15 Ataşehir / İstanbul
www.enapart.net
satis@enapart.net



PRIVADA 10 B SUR #3908 COL.
ANZUREZ, C.P. 72530, PUEBLA, PUE
www.enapart.com.mx
sales@enapart.com.mx



Friedrich-Ebert-Anlage 36, 60325
Frankfurt am Main, Germany
www.enapart.de
anfrage@enapart.de



4 boulevard Carnot, 95400
villiers-le-bel, Paris, France
www.enapart.fr
sales@enapart.fr



65049, ОДЕСА, ВУЛИЦЯ ІВАНА
ФРАНКА, БУДИНОК 55, ПОВЕРХ 3
www.enapart.com.ua
sales@enapart.com.ua



MUNICIPIUL BUCUREȘTI, SECTOR 3,
B-DUL BASARABIA, NR.250, CORP P+5
www.enapart.ro
sales@enapart.ro



〒584-0023 大阪府富田林市若松町
東2丁目2番16号
www.enapart.co.jp
sales@enapart.co.jp



PLAZA NUESTRA SEÑORA DE LAS
NIEVES 12 ,LOCAL ,50012,ZARAGOZA
www.enapart.es
ventas@enapart.es



Складова база „Онгъл“, Склад А2, п.к.
4006, гр. Пловдив, България
www.enapart.bg
sales@enapart.bg



3 Austin Mews, High Street, Hemel
Hempstead, HP1 3AF , United Kingdom
www.enapart.co.uk
sales@enapart.co.uk

VE1B systems

SKF VectoLub

Version	02
Date of issue	October 2016
Publication number	951-130-441
Languages	EN
Country/Countries	EN ...



Minimal quantity lubrication system VE1B

English translation of the original installation and operation manual

Imprint

This manual – containing installation, operation and maintenance instructions complies with EC-Machinery Directive 2006/42/EC and is an integral part of the described lubrication system. It must be kept for future use.

This manual – containing installation, operation and maintenance instructions was created in accordance with the valid standards and regulations on documentation.

© SKF

This documentation is protected by copyright. All rights reserved. The photomechanical reproduction, copying, and distribution of this documentation or parts thereof by means of processes such as data processing, data carriers, and data networks is strictly prohibited without the express permission of SKF.

Subject to editorial or technical modifications.

Service

For all technical questions, please contact:

SKF France
Lubrication Business Unit
204, bld Charles de Gaulle
B.P. 239
37540 St-Cyr-sur-Loire
FRANCE
Tel. +33 (0) 247 405 300
Fax +33 (0) 247 405 353

Or an SKF Service Centre, the addresses of which are given on our website:

lubrication-france@skf.com
www.skf.com

Contents

Imprint	2	3. Design and function	13	7.2 Permanent shutdown.	31
Service	2	3.1 Versions	13	8. Maintenance	32
Information concerning the EC Declaration of Incorporation	4	3.2 Construction	15	9. Failures	33
General	6	3.3 Function	18	10. Technical data	36
Meaning of symbols and corresponding information	6	4. Installation instructions	19	11. Spare parts and accessories ...	37
1. Safety instructions	7	4.1 Positioning and installation.	19		
1.1 Intended use	7	4.3 Outlet connection	20		
1.2 Authorized personnel	8	4.2 Inlet connection	20		
1.3 Danger relating to electric current .	8	4.4 Electric connection	24		
1.4 Danger relating to system pressure	8				
1.5 Warranty and liability	9	5. Transport, delivery and storage. ..	25		
2. Lubricants	10	5.1 Transport	25		
2.1 General	10	5.2 Delivery	25		
2.2 Selection of lubricants	11	5.3 Storage	25		
2.3 Approved lubricants	11	6. Commissioning	26		
2.4 Lubricants and the environment. .	12	6.1 General	26		
2.5 Danger relating to lubricants ...	12	6.2 Bleeding and commissioning . . .	26		
		6.3 Micropump flow rate adjustment .	27		
		6.4 Pneumatic pulse generator	29		
		6.5 Carrier air pressure regulator. . . .	29		
		6.6 Reservoir filling	31		
		7. Shutdown	31		
		7.1 Temporary shutdown	31		

Information concerning the EC Declaration of Incorporation

EC Declaration of Incorporation in accordance with EC-Machinery Directive 2006/42/EC, Appendix II Part B

The manufacturer SKF France SAS, 204, Bld Charles de Gaulle, B.P. 239 – 37540 St-Cyr-sur-Loire – FRANCE, declares herewith the conformity of the partly completed machine

Designation: Minimal quantity lubrication system
Type: VE1B
Order No.: see ID plate
Year of construction: see ID plate

with the following essential health and safety requirements of the EC Machinery Directive 2006/42/EC when released on the market.

1.1.2 · 1.13 · 1.3.2 · 1.3.4 · 1.5.1 · 1.5.6 · 1.5.8 · 1.5.9 · 1.6.1 · 1.7.1 · 1.7.3 · 1.7.4

The relevant technical documentation is compiled in accordance with part B of Annex VII of this Directive. We undertake to transmit in electronic format the relevant technical documentation in response to a reasoned request by the competent national authorities. The person empowered to draw up the declaration is the technical standards manager. See the manufacturer's address.

Furthermore the followings directives and (harmonized) standards have been applied.

2011/65/CE

RoHS II

2014/30/EU

Electromagnetic compatibility | Industry

<u>Standard</u>	<u>Issue</u>	<u>Standard</u>	<u>Issue</u>	<u>Standard</u>	<u>Issue</u>	<u>Standard</u>	<u>Issue</u>
NF EN ISO 12100	12-2010	NF EN 50581	01-2013	NF EN 61000-6-1	03-2007	NF EN 61000-6-4	03-2007
NF EN 809+A1	12-2009	NF EN 60947-5-1	09-2004	NF EN 61000-6-2	01-2006	NF EN 61000-6-3	03-2007
NF EN 60204-1	09-2006						

The partly completed machine must not be put into service until the final machinery into which it is to be incorporated has been declared in conformity with the provisions of the EC Machinery Directive 2006/42/EC and other relevant Directives.

St Cyr-sur-Loire, January 15th, 2015



Guillaume Amilien
R&D Manager
SKF France
Lubrication Business Unit



Gérard Gaudin
Production unit manager
SKF France
Lubrication Business Unit

General

Meaning of symbols and corresponding information

In this manual, the symbols and safety wordings shown on this page are intended to communicate a particular risk to persons, material assets, or the environment.

All safety instructions must be respected by person exposed to these risks. The safety instructions must be communicated to all other persons.

Instructions attached directly to the equipment, such as







- rotational direction arrows
- fluid connection labels, etc.

must be respected and remain perfectly legible.

It is essential to read these instructions thoroughly and to respect the safety instructions given.

Table 1

Hazard symbols

Symbol	Standard	Meaning
	DIN 4844-2 W000	General hazard
	DIN 4844-2 W008	Voltage
	DIN 4844-2 W026	Hot surface
	DIN 4844-2 W028	Slippery floor
	DIN 4844-2 W027	Risk of hand injury
	DIN 4844-2 W55	Risk of pollution

1. Safety instructions

The described product was manufactured in accordance with all generally acknowledged regulations pertaining to technology, occupational safety, and accident prevention. However, dangers that can cause physical injury to persons or damage to other material assets might still occur during the use of the product.



These instructions must be read and understood by all persons who are involved with the installation, operation, maintenance, and repair of the product. These instructions must be kept close to the equipment for future reference.

Note that these installation instructions is an integral part of the product. It must be handed over to the new operator of the product if the product is sold.



In addition to the information provided in the installation instructions, all generally applicable regulations on accident prevention and the environment must be observed.

1.1 Intended use

The described product is for supplying centralized lubrication systems with lubricant and is intended for use in centralized lubrication systems. Other use or use beyond this purpose is considered unintended.

Products of SKF must not be used in conjunction with substances and mixtures classified as hazardous by the Annex I part 2-5 of the CLP regulation (EC 1272/2008), and identified with hazard pictograms GHS01-GHS06 and GHS08.

None of the products manufactured by SKF can be used in conjunction with gases, liquefied gases, pressurized gases in solution and fluids with a vapor pressure exceeding normal atmospheric pressure

(1013 mbars) by more than 0.5 bar at their maximum permissible temperature.

Unless otherwise noted, products of SKF must not be used in conjunction with explosive atmospheres according to the ATEX-Directive 2014/34/EU.



All products from SKF may be used only for their intended purpose as described in this brochure and in any instructions.

1.2 Authorized personnel

The products described in the installation instructions may only be installed, operated, maintained, and repaired by qualified experts. Qualified experts are persons who have been trained, instructed, and familiarized with the end product into which the described product is installed.

These persons are considered capable of such tasks due to their education, training, and experience with valid standards, conditions, accident prevention regulations in effect, and installation conditions. They should be able to carry out the required tasks and to recognize – and thus avoid – any dangers that might otherwise occur.

A definition of what constitutes a qualified person and who are unqualified persons are stipulated in DIN VDE 0105 and IEC 364.

1.3 Danger relating to electric current

The electrical connection for the described product may only be established by qualified, instructed persons who have been authorized by the operator or owner to carry out this task. If the product is improperly connected, substantial material or personal damage may be the consequence.



DANGER!

Working on products that have not been disconnected from the power supply can cause serious injury or death to persons. Installation, maintenance, and repair work may only be carried out by qualified experts on products that have been disconnected from the power supply. The supply voltage must be turned off before any product components are opened. .

1.4 Danger relating to system pressure



DANGER!

Centralized lubrication systems are under pressure when they are being operated. Such systems must therefore be depressurized before starting installation, maintenance, or repair work and before making any changes to the system.

1.5 Warranty

The instructions do not contain any information on the warranty. This can be found in the General Conditions of Sales, which are available at: www.skf.com/lubrication.

2. Lubricants

2.1 General



All SKF products must only be used for their intended purpose and in accordance with the specifications of the installation instructions for the product in question.

The intended use of this product is for the centralized lubrication/lubrication of bearings and wear points with lubricants. All physical limitations of use stipulated in the documentation of the product such as the owner's manual, technical drawings and catalogs must be observed.

More specifically, we call your attention to the fact that substances and mixtures classified as hazardous by the Annex I part 2-5 of the CLP regulation (EC 1272/2008), and identified with hazard pictograms GHS01-GHS06 and GHS08, can only be used to feed the SKF centralized lubrication systems,

transported or distributed by these systems after consultation with SKF and obtaining written permission.

All products manufactured by SKF are not approved for use in conjunction with gases, liquefied gases, pressurized gases in solution and fluids with a vapor pressure exceeding normal atmospheric pressure (1013 mbars) by more than 0,5 bar at their maximum permissible temperature.

Should there be a need to use the product to convey media other than lubricants or hazardous substances, this must be discussed with SKF first and the company must give express written permission.

In the opinion of SKF, lubricants constitute a design element that must be considered when selecting components and designing centralized lubrication systems. The lubrication properties of the lubricants in question must be considered.

2.2 Selection of lubricants



You must observe the machinery manufacturer's information on the lubricants to be used in the machinery.

While the machinery/bearing manufacturer usually specifies lubricants, it is the owner/operator (or maintenance person) who must finally select the appropriate lubricant, with the help of the lubricant supplier. When selecting a lubricant, the type of bearing/wear point, the stresses and strains to be expected during operation, and anticipated ambient conditions must be taken into account. All financial/economic aspects must also be considered.

ance (e.g. 'oil separation' behavior) in centralized lubrication systems.

You can request an overview of lubricant tests offered by SKF from our Service Center.

2.3 Approved lubricants



DANGER!

The manufacturer of the bearing or machinery to be lubricated will specify the lubricant requirements for each point to be lubricated. You must make sure that the required quantity of lubricant is provided to the relevant lubricating point. If a lubricating point is insufficiently lubricated, the bearing may become damaged or jammed.



If required, SKF can help customers to select suitable components for the conveyance of the selected lubricant and to plan and design their centralized lubrication system.

If you have further questions, you can contact SKF.

We can test lubricants in our own laboratory to establish their suitability for convey-



DANGER!

Only lubricants that have been approved by SKF for use with the product may be used. Unsuitable lubricants can cause product malfunctions and damage to property.



DANGER!

Different lubricants must not be mixed together. Doing so can cause damage and require extensive cleaning of the products/centralized lubrication system. To prevent confusion, we recommend that you attach information indicating the lubricant to be used on the lubricant reservoir.

The described product can be operated with lubricants that comply with the specifications in the technical data.

Note that some lubricants may have properties that lie within the permitted limit values and yet not be suitable for use in centralized lubrication systems for other reasons. For example, some synthetic lubricants are not compatible with elastomers.

2.4 Lubricants and the environment



DANGER!

Lubricants can contaminate the ground and watercourses. Lubricants must be used and disposed of properly. Country specific regulations and laws on the use and disposal of lubricants must be observed.

Note that lubricants are harmful to the environment and flammable; their transportation, storage, and processing are subject to special precautionary measures. For specifications on transportation, storage, processing, and dangers to the use and the environment for the lubricant, refer to the material safety data sheet provided by or available from the lubricant manufacturer. You can ask the manufacturer of the lubricant for the material safety data sheet.

2.5 Danger relating to lubricants



DANGER!

Centralized lubrication systems must be leak-tight. Leaking centralized lubrication systems can cause a slip hazard. When performing installation, maintenance, and repairs test the centralized lubrication system for leaks. Leaky parts of the centralized lubrication system or components of the lubrication equipment have to be sealed immediately.

Leaking centralized lubrication systems or components of the lubrication equipment are a source of danger in relation to slip hazard and the risk of injury. These dangers can cause physical injury to persons or damage to other material assets.

Refer to safety precautions in the lubricant manufacturer's material safety data sheet.

Lubricants are hazardous substance. It is essential to respect any safety instructions given in the lubricant safety data sheet. You can ask the manufacturer of the lubricant for the material safety data sheet.

3. Design and function

3.1 Versions

The minimal quantity lubrication systems VE1B are available in several models. The differences are in the number of micro-pumps – 1 to 4 micropumps – and their characteristics such as flow range, adjustment mode and material. The VE1B units can also be equipped with a pneumatic pulse generator or an air solenoid valve to control all the micropumps – actuation and working frequency.

The VE1B unit can have its own integrated reservoir with a capacity of 0,3 l.

The configuration of the unit is indicated on the nameplate and delivery papers. The table 1 explains the type key.

If the VE1B has an air solenoid valve, the order number of the unit is then completed with one of the following voltage keys.

- +428: 230 V AC, 50/60 Hz
- +429: 115 V AC, 50/60 Hz
- +924: 24 V DC



If a minimal quantity lubrication unit is not listed in table 1, please refer to the delivered technical sheet to know the specific technical data of the minimal quantity lubrication unit.

Lubrication units VE1B

No.: _____ VE1B - _ - _ - _ - _ + _ _ _ _

Control type

- 0 = without
- P = pneumatic pulse generator
- E = solenoid valve

Pumps

- A = setting with metering rings, 3 to 30 mm³/ stroke, brass
- B = setting with thumb wheel, 7 to 30 mm³/ stroke, brass
- C = setting with metering rings, 3 to 30 mm³/ stroke, stainless steel
- D = setting with thumb wheel, 7 to 30 mm³/ stroke, stainless steel
- E = setting with metering rings, 30 to 90 mm³/ stroke, brass
- F = setting with thumb wheel, 30 to 90 mm³/ stroke, brass
- G = setting with metering rings, 30 to 90 mm³/ stroke, stainless steel
- H = setting with thumb wheel, 30 to 90 mm³/ stroke, stainless steel

Number of micropumps

1, 2, 3 or 4

Reservoir

- 00 = without
- 10 = with integrated reservoir 0.3 l

Voltage key

- +924: 24 V DC
- +428: 230 V 50/60 Hz
- +429: 115 V 50/60 Hz

3.2 Construction

The VE1B unit is a compact lubrication system with all functions joined on a common ground plate.

Figures 1 and 2 (→ **page 16**) show two VE1B units with the different functions.

A VE1B unit has from 1 to 4 micropumps. Different types of micropump are available according to the flow range (small flow up to 30 mm³/stroke and large flow from 30 to 90 mm³/stroke), the delivery rate setting mode (with metering rings or with thumb wheel) and the material (brass or stainless steel).

To every micropump corresponds on the opposite side of the ground plate a coaxial outlet - air and lubricant - fitted with quick connectors for the connection of the lubrication lines. The quick-release connector for the capillary tube (lubricant) is located beneath the quick-release connector for the outer tube (air). The user can set the carrier air pressure with a pressure regulator. The unit can be connected to the user's compressed air network via a G 1/4 port. Another port, G 1/4, is on the opposite side for the connection to a separate reservoir. Nevertheless the VE1B unit can have an integrated transparent reservoir with a capacity of 0.3 l.

The VE1B unit might have a pneumatic pulse generator or a pneumatic solenoid valve for the actuation and the working frequency adjustment of the micropump(s).

The unit can be fixed on the machine frame with a standard fixation rail and clips. It can also be equipped with magnets, which enhance its availability.

Fig. 1

Minimal quantity lubrication system VE1B

1 reservoir 0,3 l

2 coaxial outlet

3 pneumatic pulse generator

4 micropump, setting with thumb wheel

5 carrier air pressure regulator

6 air inlet port (beneath)

7 Solenoid valve

8 lubricant inlet port

9 micropump, setting with metering rings

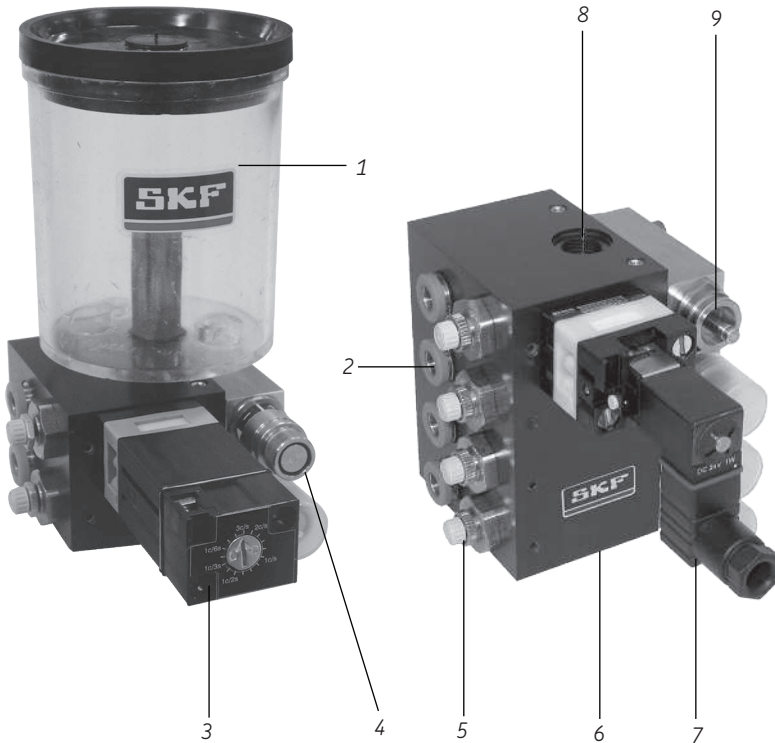

Fig. 2

VE1B dimensions

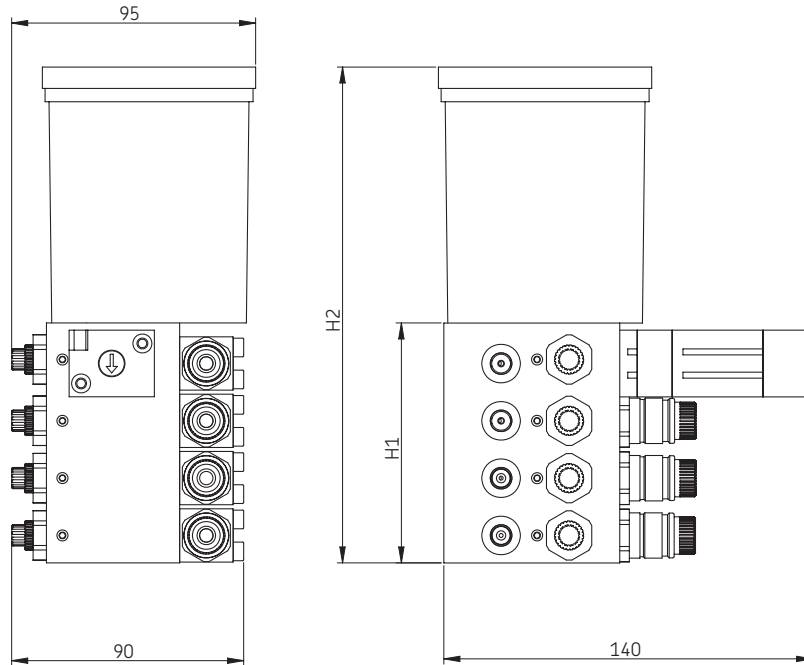

Table 2

VE1B dimensions

Number of micropumps	H1	H2
1	26	122
2	45	141
3	90	186
4	90	186

3.3 Function

When the VE1B unit is switched on, it is supplied with compressed air (5 to 8 bars) and with lubricant (0,1 to 0,5 bar).

The VE1B unit is fed in lubricant from the integrated reservoir, capacity 0.3 l, or from the user's external reservoir. The lubricant flows through the base to the volumetric pneumatic micropumps. The delivery frequency of all micropumps (max. 3 stroke/s) is adjusted with either a pneumatic pulse generator or a solenoid valve, which is controlled via a control unit. The flow rate of the micropump can be adjusted with metering rings or with a thumb wheel.

The micropump delivers a metered quantity of lubricant, which goes through the inner channel of the base to the coaxial outlet port.

Compressed air is also supplied to the unit from the user's network. In general the air inlet is controlled with a solenoid valve (here as option).

The compressed air flows through the ground plate of the unit and is distributed on the one hand to each micropump, and on the other hand to the coaxial outlets to be used as carrier air. Every outlet has a regulating valve to adjust the pressure of the

carrier air. The low-pressure carrier air and lubricant are simultaneously transported via the coaxial hose to the nozzle. The carrier air is swirled in the nozzle. As a result, the metered quantity of lubricant is broken down into microdroplets, which are transported by the carrier air to the friction point without causing any mist.

With a correct adjustment of the projection air, the size of the microdroplets is between 200 and 600 μm . It is then possible to get a homogeneous lubricant coating of the contact surface.

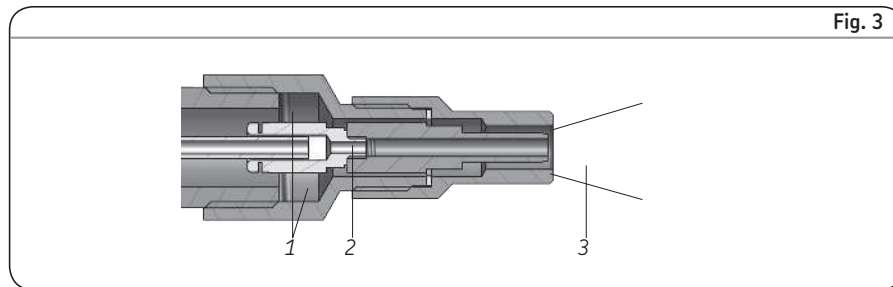

Projection nozzle for VE1B

- 1 Carrier air
- 2 Lubricant
- 3 Turbulence zone

4. Installation instructions

The minimal quantity lubrication system described in the mounting instructions may only be installed, operated, maintained, and repaired by qualified experts. Qualified personnel are persons who have been trained, instructed, and familiarized by the user of the end product into which the system is installed. These persons are considered capable of such tasks due to their education, training, and experience with valid standards, conditions, accident prevention regulations in effect, and installation conditions. They should be able to carry out the required tasks and to recognize – and thus avoid – any dangers that might otherwise occur.

A definition of what constitutes a qualified person and who are unqualified persons are stipulated in DIN VDE 0105 and IEC 364.

Before installing/positioning the minimal quantity lubrication system, remove the packaging material and any transportation safety devices such as sealing plugs. Keep the packaging material until any and all problems have been clarified.



CAUTION!

The lubrication system must not be tipped over or thrown.

Country-specific accident prevention regulations and the operating and maintenance instructions for the operator must be observed when carrying out all installation work on machines.

4.1 Positioning and installation

The system must be protected from moisture and vibrations but on the other hand mounted so that it is easily accessible to ensure that all further installation work can be carried out without difficulty. Ensure that there is sufficient circulating air to prevent the system from overheating. For information on the maximum permitted ambient temperature, see technical data.



CAUTION!

The minimal quantity lubrication system must be securely fixed to its support to avoid accidental tipping. If the system falls it could be damaged or cause damages and can also injure an operator or another person.

4.2 Inlet connection

4.2.1 Lubricant inlet connection

If the VE1B unit has no integrated reservoir, it has an inlet port G 1/4 for lubricant supply. (→ fig. 1 page 16)

4.2.2 Air inlet connection

The compressed air line must be connected to the system in such a way that once mounted, no force is applied to the pump (no pressure on the connection).

It is important to use pipes that are sufficiently long so that maintenance and repairs can be carried out at a later time without hindrance.



For the good function of a VE1B unit, the air pressure inlet shall not exceed 7 bars.



DANGER!

Before connecting the pump to the compressed air feed ensure that the main air valve is closed.

The compressed air quality must comply with purity class 5 defined by DIN ISO 8573-1:

- Maximum particle size: 5 μm
- Maximum particle content: 10 mg/m^3
- Pressure dew point: 7 $^{\circ}\text{C}$
- Maximum water content : 7 800 mg/m^3
- Residual oil content max.: 25 mg/m^3

The VE1B systems have can be connected to the user's compressed air network via a G 1/4 port. The air inlet port is on the opposite side of the one for lubricant.

4.3 Outlet connection

4.3.1 Connection coaxial line / outlet port



The coaxial line may be only connected by authorized and trained specialists.



The coaxial line has first to be connected to the outlet port of the VE1B, and then to the nozzle.



It is recommended to identify an outlet in accordance with the nozzle it supplies, e.g. with tubes of different colors, with identification rings or others.

The coaxial line (from 1 to 5 m*) is connected to the VE1B outlet port by means of quick-release connectors.

*) For greater line length, please contact the SKF service center.

Every outlet port has two quick-release connectors (→ fig. 4).

The lower connector holds the capillary tube of the line (lubricant). The upper connector (orange collar) holds the outer tube of the coaxial line (air).

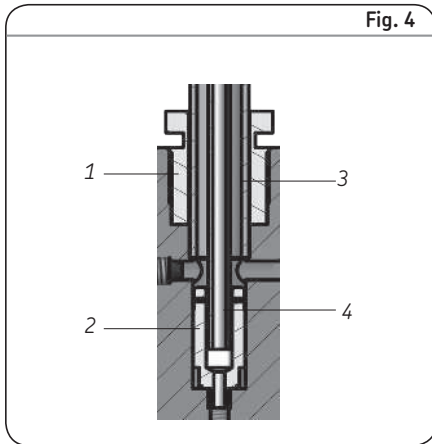

Cross-section view of the outlet port

- 1 Upper quick-release connector
- 2 Lower quick-release connector
- 3 Outer tube of the coaxial line
- 4 Capillary tube of the coaxial line

- Pull out (ca. 10 cm) the capillary tube from the coaxial line
- Insert the capillary tube into the outlet port and fit it to the lower quick-release connector (→ **A fig. 5**).
- Pull slightly the capillary tube to check it is correctly held.
- Insert the outer tube into the outlet port and fit it to the upper quick-release connector (→ **B fig. 5**).
- Pull slightly the outer tube to check it is correctly held.

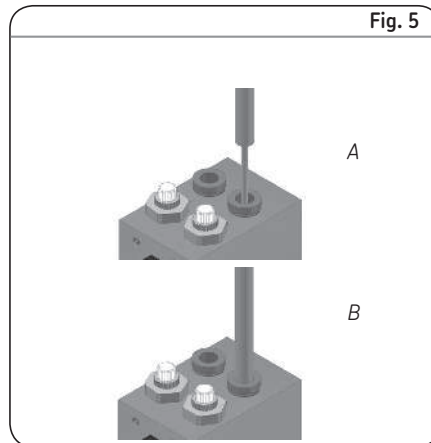

4.3.2 Connection coaxial line / projection block

! The coaxial line may be only connected by authorized and trained specialists.

! The coaxial line can be connected to the projection block only if it is already connected to the outlet port of the VE1B.

! When mounting or dismounting, never twist, bend or crush the coaxial tube.

The length of the coaxial line between the outlet port of the module and the nozzle has to be between 1 and 5 m. For greater length, please contact the SKF service center.

Step 1 (→ **fig. 6**).

- Unscrew and remove the nozzle (1) from the end tube (rigid or articulated) (3).
- Slip the capillary (7) into the quick connector (6) of the fixing block (5) until it is coming out of the end tube (3).

Step 2

- Insert the outer tube (8) of the coaxial hose (9) into the quick connector (6) of the fixing block (5).
- Pull carefully the hose (9) to check that the outer tube (8) is correctly fixed.
- Stretch the capillary tube (7) from the end tube (3) and cut it (15 to 25 mm out of the tube). Maintain the capillary tube otherwise it will retract.

Step 3

- Insert the capillary tube (7) into the quick connector (10) of the nozzle (1).
- Pull carefully the capillary tube (9) to check it is correctly fixed.

Step 4

- Screw in and tighten the nozzle (1) onto the end tube (3).

Fig. 6

Connection coaxial line/nozzle

- 1 Nozzle
- 2 Union end tube - nozzle
- 3 End tube
- 4 Union fixing block - end tube
- 5 Fixing block
- 6 Quick-release connector
- 7 Capillary tube of the coaxial line
- 8 Outer tube of the coaxial line
- 9 Coaxial line
- 10 Quick-release connector

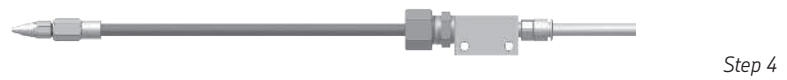
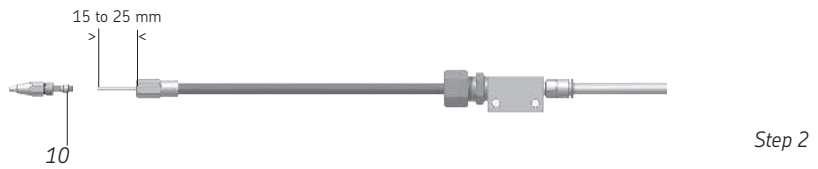
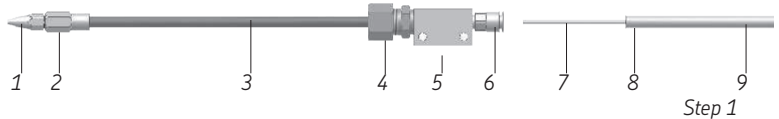

4.4 Electric connection



DANGER!

Only qualified personnel with specific training and authorization from the user may hook up the electrical connections on the MQL system. The connection conditions and the local regulations (e.g. DIN, VDE, NF) must be scrupulously respected. Any unsuitable connections on the MQL system may result in serious material damage and bodily injury.



DANGER!

The supply voltage on site must agree with the information on the codification of the VE1B unit. Check the fusing of the circuit. Use only the original fuse with the required ampere value. If other fuses are used, damage to property of personal injury may be the consequence.

4.4.1 Solenoid valve connection

Wiring depends on the operating voltage of the solenoid valve. The voltage key at the end of the VE1B number indicates the operating voltage.

Fig. 7

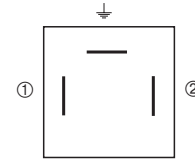

Electrical connection

VE1B unit with the following voltage key:

- +428 (230 V CA, 50/60 Hz) or
- +429 (115 V CA, 50/60 Hz)

Fig. 8

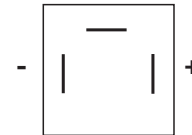

Electrical connection

VE1B unit with the following voltage key:

- +924 (24 V DC)

5. Transport, delivery and storage

5.1 Transport

SKF products are packaged in accordance with the regulations of the recipient country and in accordance with DIN ISO 9001. Our products must be transported with care. Products must be protected against mechanical influences such as impacts. Transport packaging must be labelled with the information 'Do not drop!'.



The product must not be tipped up or dropped.

There are no restrictions relating to land, air, or sea transportation.

5.2 Delivery

Following receipt of the shipment, the product or products must be checked for damage and the shipping documents should be used to make sure that the delivery is complete. Keep the packaging material until any and all problems have been clarified.

5.3 Storage

The following conditions apply to the storage of SKF products.

5.3.1 Storage of lubrication units

- Ambient conditions: dry, dust-free environment; storage in well-ventilated, dry area
- Storage time: 24 months max.
- Permitted air humidity: < 65%
- Warehouse temperature: 10 – 40 °C
- Light: direct sunlight/UV radiation must be avoided; nearby sources of heat must be screened

5.3.2 Storage of electronic and electrical devices

- Ambient conditions: dry, dust-free environment; storage in well-ventilated, dry area

- Storage time: 24 months max.
- Permitted air humidity: < 65%
- Warehouse temperature: 10 – 40 °C
- Light: direct sunlight/UV radiation must be avoided; nearby sources of heat must be screened

5.3.3 Storage – general information

- Ensure that no dust gets into stored products by wrapping them in plastic film
- Store products on racks or pallets to protect them from damp floors
- Before placing products into storage, protect uncoated metal surfaces – and drive parts and mount surfaces in particular – from corrosion using long-term corrosion protection.

6. Commissioning

6.1 General

The minimal quantity lubrication system described here runs automatically. However it is recommended that you regularly visually check the transport of lubricant in the lines and the lubricant projection at the nozzles.

The level of lubricant in the reservoir must be checked visually at regular intervals. When the lubricant level is at a minimum, refill the reservoir according to the instructions described in the chapter *Reservoir filling*.



Always respect the equipment manufacturer's recommendations concerning which lubricant to use.



Lubricant should not be sprayed at a person nor on a hot/incandescent body.



CAUTION!

Only clean lubricant may be used. Contaminated lubricants can result in serious system malfunctions.



CAUTION!

Different lubricants must not be mixed together. Doing so can cause damage and require extensive cleaning of the lubrication system. To prevent any risk of error, it is recommended to clearly identify the lubricant used on the reservoir.



CAUTION!

Depending on the nature of the lubricant used, the user should wear protective equipment such as glasses, a mask and gloves. For further information please consult the technical file and the safety data sheet for the lubricant used.

6.2 Bleeding and commissioning

Before starting the VE1B unit, check that all outer connections (reservoir, air supply, lube lines to the nozzles...) have been well mounted and tightened.

6.2.1 Startup

- Bleed the VE1B (micropumps) unit before starting.
- Set the micropump metered volume according to the needs.
- Set the micropump working frequency according to the needs.

When the VE1B unit is in operation, you can adjust the carrier air pressure at any time with the air pressure regulator. With a higher flow rate, you get a finer atomization of the lubricant, and the lubrication is then more homogeneous all over the surface to be lubricated.

 To ensure the good function of the micropumps with thumb wheel, the minimal flow rate has to be above 7 mm³/stroke.

 If the carrier air pressure is too high, there will be a problem with the atomization. The lubricant particles would be too fine and may keep suspended in the air.

6.2.2 Bleeding the micropumps

- Set all the micropumps to their maximal flow rate.
- Let the micropumps operate until lubricant is coming out from the nozzles.

 In the case of a VE1B unit with only 3 micropumps, the unused outlet for air has to be closed. Therefore turn the corresponding pressure regulator fully to the right.

6.2.3 Neutralizing the micropump delivery

A nozzle can be switched out at any time without disturbing the good function of the other nozzles fed by the VE1B unit.

Procedure

- Switch off the carrier air flow. Therefore turn the air pressure regulator fully to the right (air flow reduced to 0).
- Switch off the lubricant flow. Therefore adjust the micropump flow rate to 0 (with the '0' metering ring, or turn the thumb wheel fully to the left).

6.3 Micropump flow rate adjustment

There are two different possibilities to adjust the flow rate of the micropump. It can be adjusted by the use of a thumb wheel or metering rings.

 The VE1B unit has to be disconnected from power before any adjustment.

 Before adjusting the micropump flow rate, the VE1B unit has to be depressurized.

 Table 3 on page 30 helps you for an optimal adjustment of the micropump flow rate. It shows the flow rate (mm³ per minute) according to the metered volume adjustment and the working frequency of the micropump.

6.3.1 Adjustment with thumb wheel

- Remove the protection cap from the thumb wheel.
- Turn the thumb wheel to the left to reduce and to the right to increase the flow rate.
- A complete turn of the thumb wheel corresponds to a flow rate of 5 (small flow) or 15 mm³ / stroke (large flow).
- Put back the protection cap on the thumb wheel.

! When the VE1B unit is delivered, the delivery rate of the micro-pump is set at the maximum (30 or 90 mm³ / stroke according to the model).

! We suggest to start the setting from the maximal flow rate (thumb wheel fully turned to the right)

6.3.2 Adjustment with metering ring

- Remove the protection cap from the thumb wheel.
- Remove the clip from the groove.

- Remove the metering ring (when one) and put the new metering ring. Figure of delivered volume is embossed on every metering ring.
- Put back the clip on the groove.
- Put back the protection cap on the thumb wheel.

! When the VE1B unit is delivered, the micropumps have a set of different metering rings (0, 3, 5, 10, 15 and 20 mm³ or 0, 30, 45 and 60 mm³).

! When the micropump has no metering ring, it is set at the maximal flow rate (30 or 90 mm³/stroke according to the model).

Fig. 9

Micro-pump with thumb wheel



Fig. 10

Micro-pump with metering ring



6.3.3 Neutralizing the micropump delivery

The micropump lubricant outflow can be neutralized at any time.

For the micropump with adjustment of the flow rate with thumb wheel: fully turn the thumb wheel to the left.

For the micropump with adjustment of the flow rate with metering rings: replace the current metering ring (when there is one) by the '0' metering ring.



The '0' metering ring is very important in order to neutralize the micropump lubricant outflow. Do not lose it.

6.4 Pneumatic pulse generator

The pulse generator adjusts the working

frequency of all micropumps. The frequency is indicated on the pulse generator in pulses (piston stroke) per second. The values on the generator are indicative and may vary according to the air inlet pressure.

- Use a slotted screwdriver to adjust the pneumatic pulse generator.

6.5 Carrier air pressure regulator

Every outlet port has a carrier air pressure regulator. According to the needs of the nozzle corresponding to this outlet, it is possible to increase or reduce this carrier air pressure.

- Turn the regulator to the left (front view of the module as in page 9) to build up the pressure and to the right to reduce it.
- Loosen the counter nut to block the flow regulator in order to prevent any accidental modification of the pressure.



When the pressure regulator is completely turned to the right, there is no more carrier air flow.



Fig. 11

Pulse generator setting scale

Fig. 12

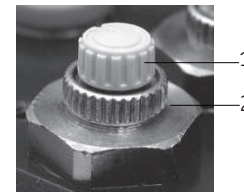

Pressure regulator

- 1 Carrier air pressure regulator
- 2 Locking counter nut

Table 2 The Vectometer shows different flow rate (in mm³ per minute) according to the lubricant flow rate and the working frequency of the micropump.

Setting [mm ³ / stroke]	Micropump working frequency [stroke/minute]										
	2.5	6	8.5	10	20	30	60	90	120	150	180
3	7.5	18	25.5	30	60	90	180	270	360	450	540
5	12.5	30	42.5	50	100	150	300	450	600	750	900
10	25	60	85	100	200	300	600	900	1,200	1,500	1,800
15	37.5	90	127.5	150	300	450	900	1,350	1,800	2,250	2,700
20	50	120	170	200	400	600	1,200	1,800	2,400	3,000	3,600
25	62.5	150	212.5	250	500	750	1,500	2,250	3,000	3,750	4,500
30	75	180	255	300	600	900	1,800	2,700	3,600	4,500	5,400
45	112.5	270	382.5	450	900	1,350	2,700	4,050	5,400	6,750	8,100
60	150	360	510	600	1,200	1,800	3,600	5,400	7,200	9,000	10,800
90	225	540	765	900	1,800	2,700	5,400	8,100	10,800	13,500	16,200

6.6 Reservoir filling

- Remove the plug/cover from the reservoir and fill with lubricant.
- Put back the plug/cover on the reservoir.



Only authorized lubricants for the pump type may be supplied. Un-suitable fluids may cause the unit to fail and lead to serious material damage and bodily injury.



Ensure the reservoir is filled with lubricant that does not contain air bubbles.



If the ambient air is polluted, set aside a clean zone to fill the system and thereby prevent foreign bodies from entering. It is also important to clean the reservoir cover or the filler plugs before removing them.

7. Shutdown

7.1 Temporary shutdown

You can temporarily shut down the described product by disconnecting the electrical, pneumatic, and/or hydraulic supply connections. For more information, see the section General information in this installation instructions.

If you wish to shut down the product temporarily, refer also to the instructions in the section Transport, delivery, and storage of this manual.

When placing the product back into operation, refer to the information in the sections Installation and Commissioning of this manual.

7.2 Permanent shutdown

All country specific legal guidelines and legislation on the disposal of contaminated equipment must be observed when shutting down the product for the final time.



Caution!

Lubricants can contaminate the ground and watercourses. Lubricants must be used and disposed of properly. Country specific regulations and laws on the use and disposal of lubricants must be observed.

The system can also be taken back by SKF for disposal if the costs are covered.

8. Maintenance



CAUTION!

Working on products that have not been disconnected from the power supply can cause serious injury or death to persons. Installation, maintenance, and repair work may only be carried out by qualified experts on a product that is not connected to a power supply. The supply voltage must be turned off before any product components are opened.



CAUTION!

The lubrication system may be under pressure. Centralized lubrication systems must therefore be depressurized before starting installation, maintenance, or repair work and before making any changes to the system.



CAUTION!

The described product may be under pressure when it is being operated. The product must therefore be depressurized before starting installation, maintenance, or repair work and before making any changes to the system.

The VE1B units are for the most part maintenance free. To ensure they work properly, however, please regularly check the following:

- Regularly check the level of lubricant in the reservoir and, if necessary, replace refill the reservoir.
- Check the system regularly for external damages and leaks.
- All electrical connections and lines must be checked regularly for damage and to ensure that they are firmly in place.
- Any faults found must be properly rectified before the system is activated again.



You must not dismantle the product or parts of the product during the warranty period. Doing so invalidates all warranty claims.

Only original SKF spare parts may be used. It is prohibited for the operator to make alterations to the product or to use non original spare parts and resources. Doing so invalidates all warranty claims.

SKF is not liable for damage caused by improper installation, maintenance, or repair work.

9. Failures

Table 4 gives an overview of possible malfunctions and their causes. If you are unable to rectify the malfunction, please contact SKF Service Center.

 You must not dismantle the product or parts of the product during the warranty period. Doing so invalidates all warranty claims.

 All other work relating to installation, maintenance, and repair must only be carried out by SKF Service.

 Only original SKF spare parts may be used. It is prohibited for the operator to make alterations to the product or to use non original spare parts and resources.



CAUTION!

Working on products that have not been disconnected from the power supply can cause serious injury or death to persons. Installation, maintenance, and repair work may only be carried out by qualified experts on products that are not connected to a power supply. The supply voltage must be turned off before any product components are opened.



CAUTION!

Centralized lubrication systems are under pressure when they are being operated. Centralized lubrication systems must therefore be depressurized before starting installation, maintenance, or repair work and before making any changes to the system.

Table 4

Failure analysis and remedy

Problem	Cause	Remedy
No lubricant at the nozzle outlet	No lubricant at the nozzle outlet	Check the lubricant level in the reservoir and fill it if necessary Check the tightness of the line reservoir/VE1B unit (connectors and hose). If necessary change the faulty part.
	Unsuitable lubricant	Empty the entire centralized lubrication system of unsuitable lubricant and fill it with new lubricant. The old lubricant must be properly disposed of.
	The micropump does not deliver	See fault "pump does not work"
	Faulty line outlet/nozzle	Check the tightness of the connectors and the coaxial line. If necessary change the faulty part.
	Reservoir stop cock closed	Open the stop cock
No air at the nozzle outlet	Problem of general air supply	Check the tightness of the line air supply line/VE1B unit (connectors and hose). If necessary change the faulty part. Check if the air supply line is correctly connected to the VE1B air inlet port.
	Carrier air pressure regulator faulty or set to zero	Check the good function and the setting of the carrier air flow regulator
	Faulty line outlet/nozzle	Check the tightness of the connectors and the coaxial line. If necessary change the faulty part. Check if the coaxial line is not bent

Failure analysis and remedy

Problem	Cause	Remedy
The micropump does not work	Wrong setting of the metered volume of the micropump	Check the setting of the metered volume of the micropump
	No air supply to the micropump	Check the good function of the general air solenoid valve or of the air solenoid valve of the micropump <ul style="list-style-type: none"> • Check the electric connection of the solenoid valve • Check the good function of the solenoid valve with the manual control
	The pulse generator is faulty or not correctly set	Check the good function and the setting of the pulse generator
Air noise	The air line is leaking	Check the pressurized air supply line. If the line is faulty change it. Check the outer tube of the coaxial line. If the tube is faulty change the coaxial line.

10. Technical data

Table 5

Technical data

VE1B system

VE1B unit

Number of outlets	1 to 4
Min. air inlet	400 NI/min, dry and filtered air (5 µm)
Air inlet pressure	5 to 8 bars
Micropump flow rate	3, 5, 10, 15, 20 and 30 mm ³ /stroke (small flow, metering rings) 7 to 30 mm ³ / stroke (small flow, thumb wheel) 30, 45, 60, and 90 mm ³ /stroke (large flow, metering rings) 30 to 90 mm ³ / stroke (large flow, thumb wheel)
Max. pump working frequency	3 strokes/s
Lubricant	mineral or synthetic oils, biodegradable oils
Eff. viscosity (at operating temperature)	10 to 400 mm ² /s
Service temperature	10 to 50 °C
Audible emissions	Cat. A (≤ 70 dB)
Fixing rail	EN 50035 or EN 50022

Solenoid valve – Electric pulse generator

Delivery rate (at 6 bars)	150 NI/min
Power supply	115 V – 50/60 Hz – 2,5 W or 230 V – 50/60 Hz – 2,5 W or 24 V – 1 W
Protection	IP 65
Mechanical life	1,5 × 10 ⁷ switching operations

Pneumatic pulse generator

Delivery rate (at 6 bars)	170 NI/min
Mechanical life	1 × 10 ⁷ switching operations
Frequency	0,166 to 3 Hz

11. Spare parts and accessories



Only original SKF spare parts may be used. It is prohibited for the operator to make alterations to the product or to use non original spare parts and resources.

Table 6

List of spare parts

Order No.	Designation
PV.1975.0.30	Set of metering rings for micropump (0 to 30 mm ³)
PV.2063.0.90	Set of metering rings for micropump (0 to 90 mm ³)
PV-2126	Set of seals (tightness between the micropump and the base plate)
SY.9243.N	Pneumatic pulse generator
AC-4680+----	Solenoid valve 3/2 NC (air for the actuation of the micropump)
MOD-1001	Carrier air flow regulator
PV-003-MOD	Micropump, max. flow rate 30 mm ³ /stroke, adjustment with rings
PVR-003-MOD	Micropump, max. flow rate 30 mm ³ /stroke, thumb wheel
PVI-003-MOD	Micropump, max. flow rate 30 mm ³ /stroke, rings, stainless steel
PVRI-003-MOD	Micropump, max. flow rate 30 mm ³ /stroke, thumb wheel, stainless steel
PV-005-MOD	Micropump, max. flow rate 90 mm ³ /stroke, rings
PVR-005-MOD	Micropump, max. flow rate 90 mm ³ /stroke, thumb wheel
PVI-005-MOD	Micropump, max. flow rate 90 mm ³ /stroke, rings, stainless steel
PVRI-005-MOD	Micropump, max. flow rate 90 mm ³ /stroke, thumb wheel, stainless steel

List of accessories

Order No.	Designation
MOD-1016+----	General air solenoid valve
AC-3228-M	Magnetic base
MOD-1011	Fixation rail and clips
RC.802	Quick-release connector Ø8, lubricant inlet
RC.803.N	Quick-release connector Ø8, air inlet

! **Important information on product usage**

SKF and Lincoln lubrication systems or their components are not approved for use with gases, liquefied gases, pressurized gases in solution and fluids with a vapor pressure exceeding normal atmospheric pressure (1 013 mbar) by more than 0,5 bar at their maximum permissible temperature.

SKF France

Lubrication Business Unit

204, bld Charles de Gaulle, B.P. 239

37540 St-Cyr-sur-Loire – FRANCE

Tel. +33 (0) 247 405 300 Fax +33 (0) 247 405 353

lubrication-france@skf.com

© SKF is a registered trademark of the SKF Group.

© Group SKF 2016

The contents of this publication are the copyright of the publisher and may not be reproduced (even extracts) unless prior written permission is granted. Every care has been taken to ensure the accuracy of the information contained in this publication but no liability can be accepted for any loss or damage whether direct, indirect or consequential arising out of the use of the information contained herein.

PUB 951-130-441/2 EN • October 2016

